

# The Reading Wizards

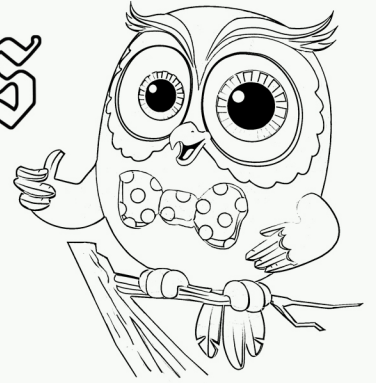

## Lesson 60A - Words with IGHT

Directions: Circle the word that matches the picture.

1.

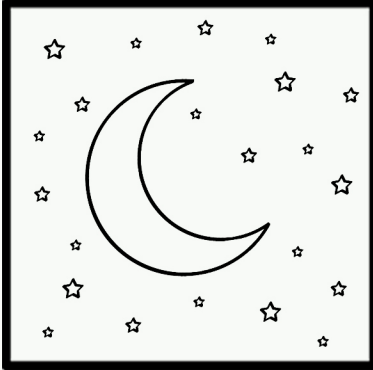

light  
bright  
fight  
night

4.

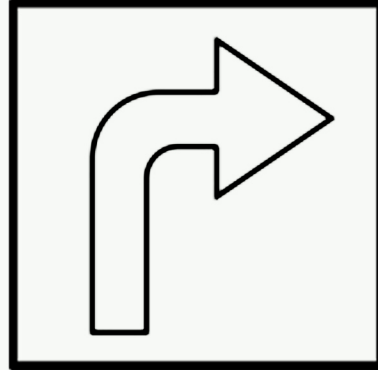

bright  
fight  
right  
flight

2.

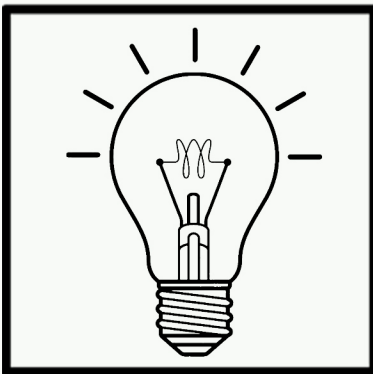

light  
bright  
fight  
night

5.

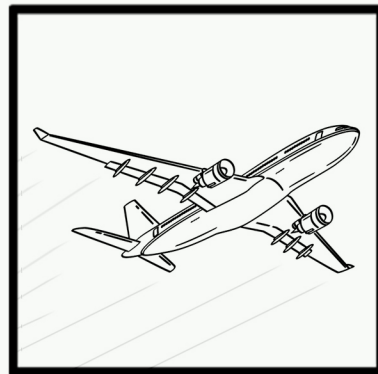

bright  
fight  
right  
flight

3.



light  
bright  
fight  
night

6.

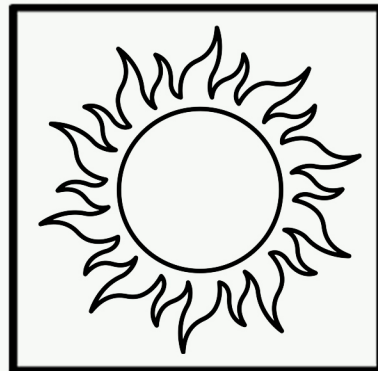

bright  
fight  
right  
flight

# The Reading Wizards



## Lesson 60A - Words with IGH T

Directions: Draw a line from the picture to the correct word.

1.

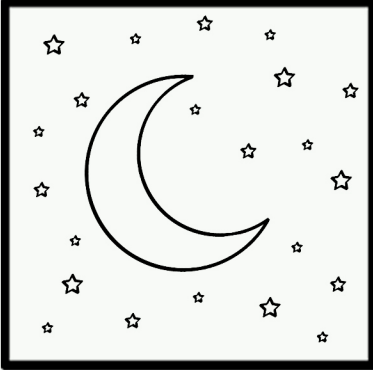

bright

fight

4.

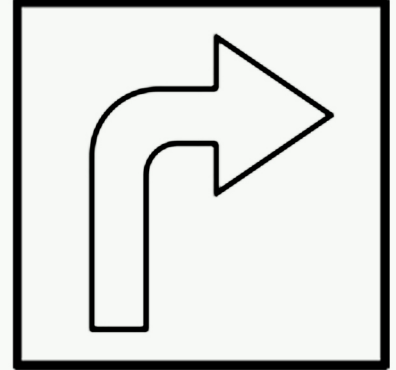

2.

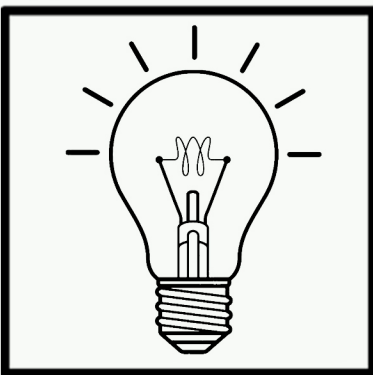

night

right

5.

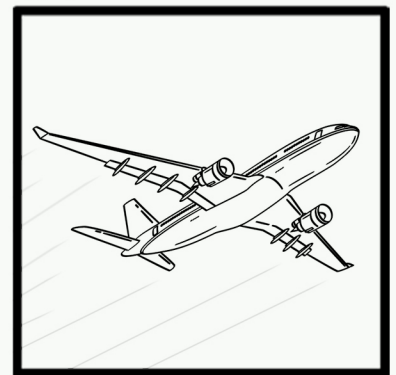

3.



light

flight

6.

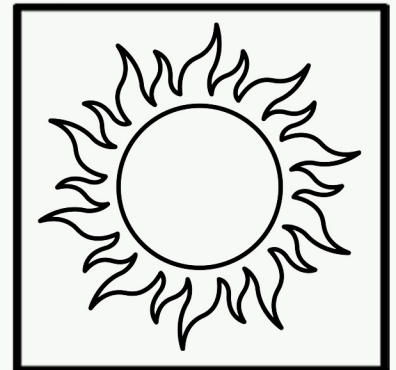

# The Reading Wizards

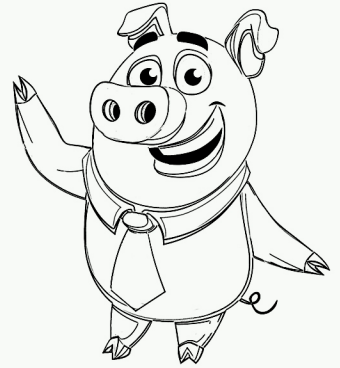

## Lesson 60A - Words with IGHT

Directions: Write the word on the line that matches the picture.  
You can use the words in the box to help you with spelling.

bright night light fight right flight

1.

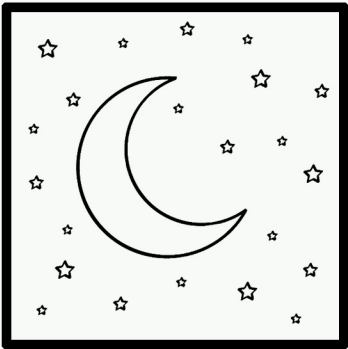

\_\_\_\_\_

-----

\_\_\_\_\_

4.

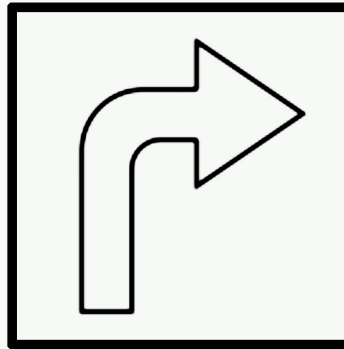

\_\_\_\_\_

-----

\_\_\_\_\_

2.

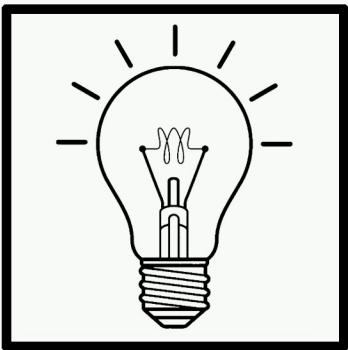

\_\_\_\_\_

-----

\_\_\_\_\_

5.

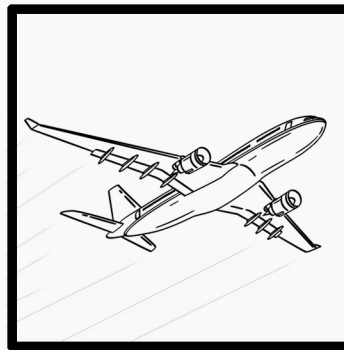

\_\_\_\_\_

-----

\_\_\_\_\_

3.



\_\_\_\_\_

-----

\_\_\_\_\_

6.

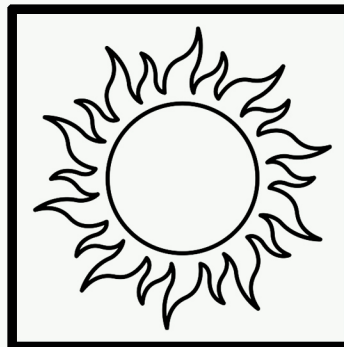

\_\_\_\_\_

-----

\_\_\_\_\_

# The Reading Wizards



## Lesson 60A - Words with IGH

Directions: Unscramble each word that matches the picture.

1.

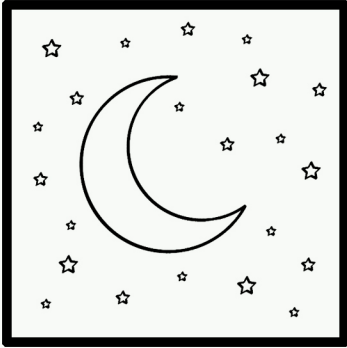

g t i n h

-----

4.

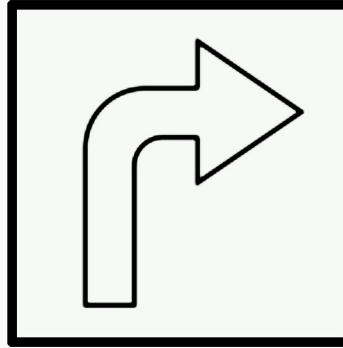

h g r t i

-----

2.

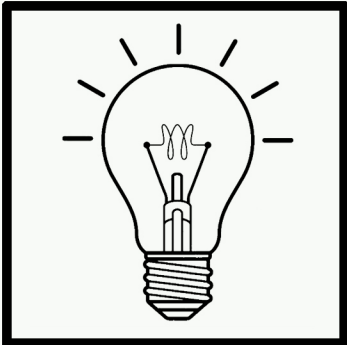

t i g l h

-----

5.

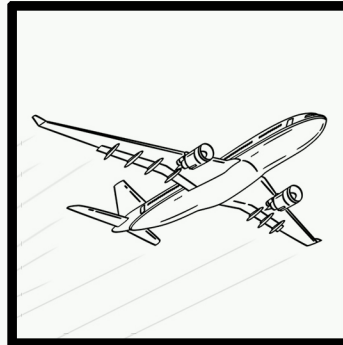

g l t i f h

-----

3.



i t g f h

-----

6.

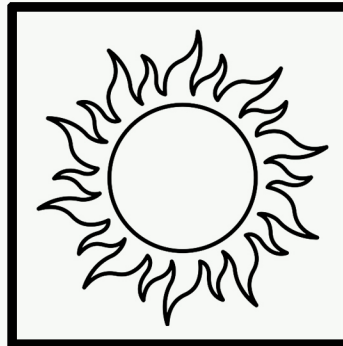

h r t b i g

-----

# The Reading Wizards



## Lesson 60A - Words with IGH T

Directions: Circle the words in the puzzle that match the list of words below.

bright night light fight right flight

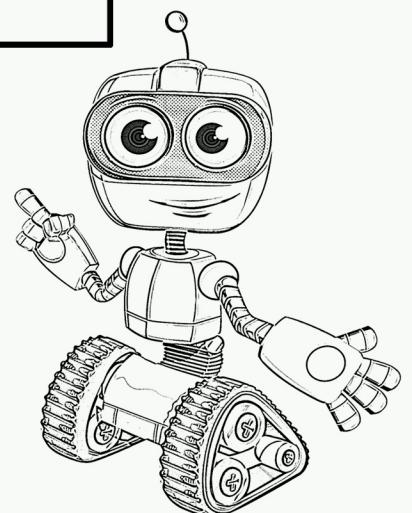
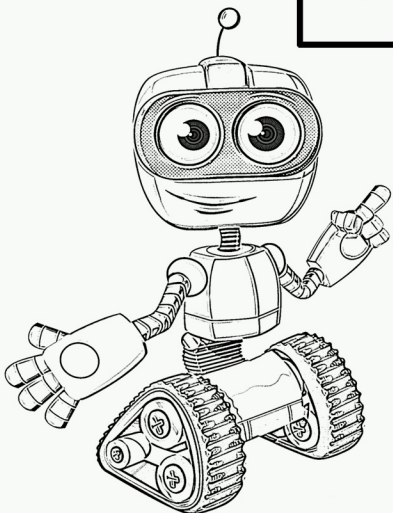
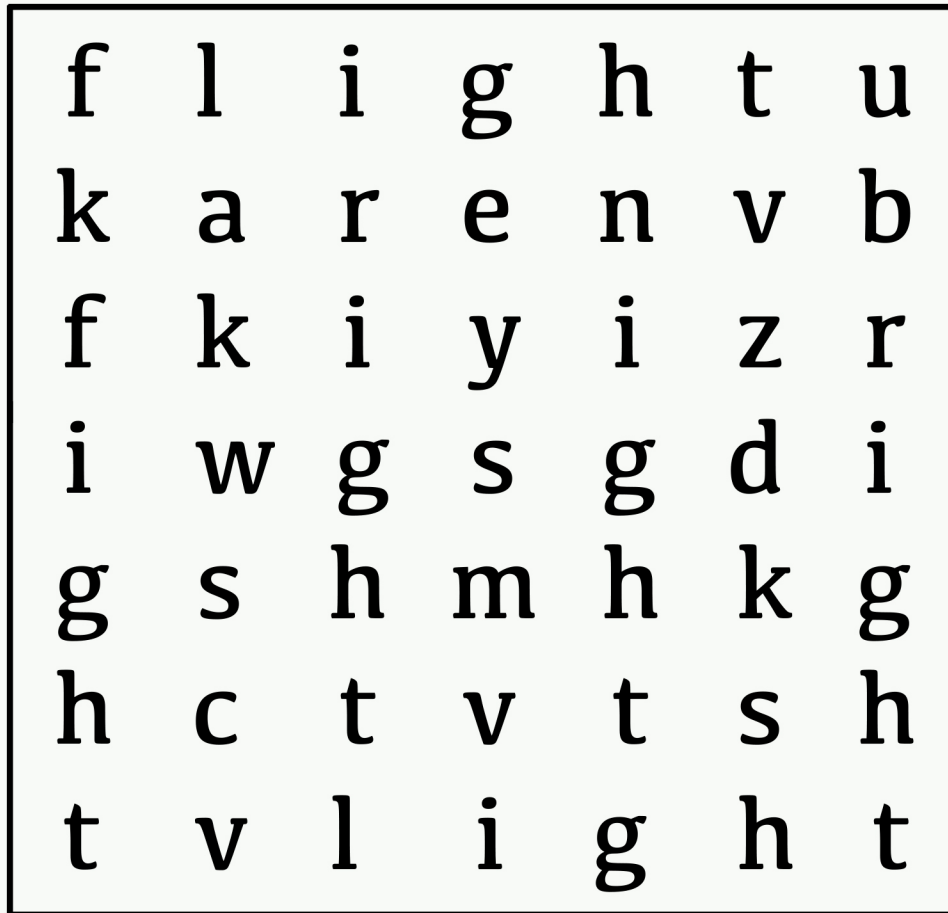

# The Reading Wizards

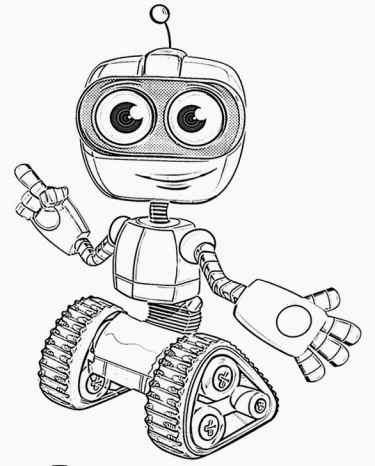

Lesson 60A - Sentences.

Directions: Unscramble the words so that the sentences make sense.

1. at right Turn light. the

---

---

---

2. are The tonight. stars bright

---

---

---

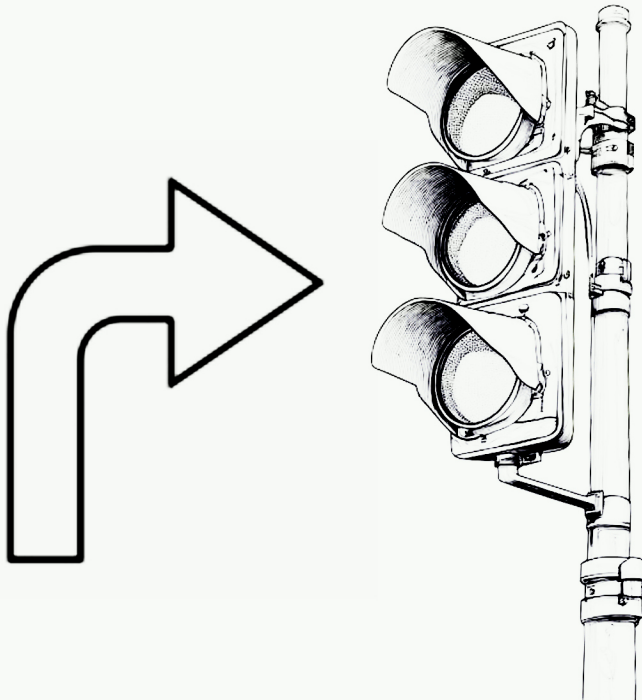

# The Reading Wizards

Lesson 60A - Answer key to Wordsearch and sentences.

Wordsearch answer key:

bright night light fight right flight

f	l	i	g	h	t	u
k	a	r	e	n	v	b
f	k	i	y	i	z	r
i	w	g	s	g	d	i
g	s	h	m	h	k	g
h	c	t	v	t	s	h
t	v	l	i	g	h	t

Sentences answer key:

1. Turn right at the light.
2. The stars are bright tonight.