

# The Reading Wizards



## Lesson 34B - Short and long U words with silent E

Directions: Circle the word that matches the picture.

1.



cut  
cube  
tub  
cute

4.

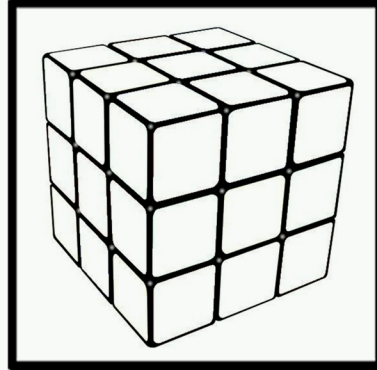

cub  
tube  
cut  
cube

2.

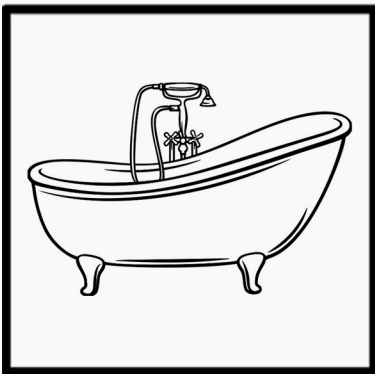

cut  
cube  
tub  
cute

5.

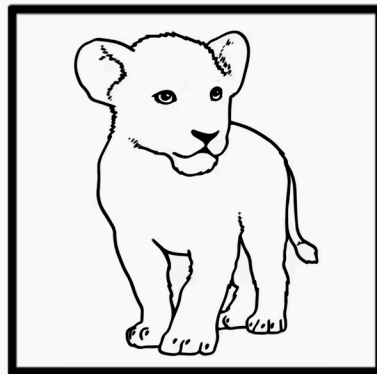

cub  
tube  
cut  
cube

3.



cut  
cube  
tub  
cute

6.

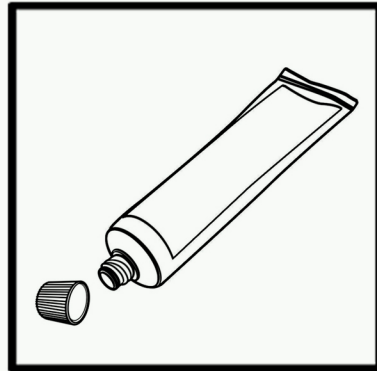

cub  
tube  
cut  
cube

# The Reading Wizards



## Lesson 34B - Short and long U words with silent E

Directions: Draw a line from the picture to the correct word.

1.

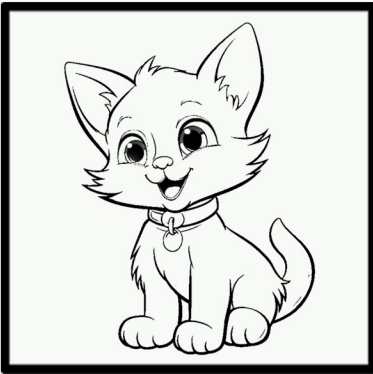

cut

tube

4.

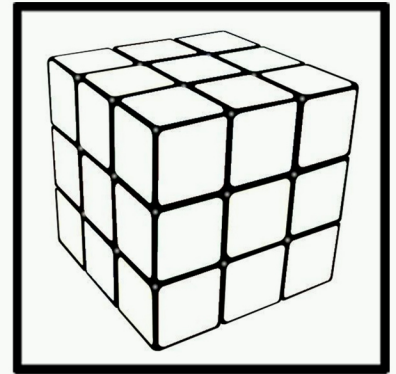

2.

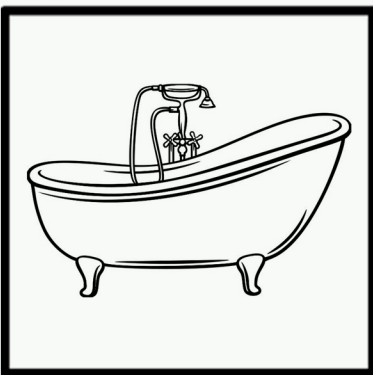

cute

tub

5.

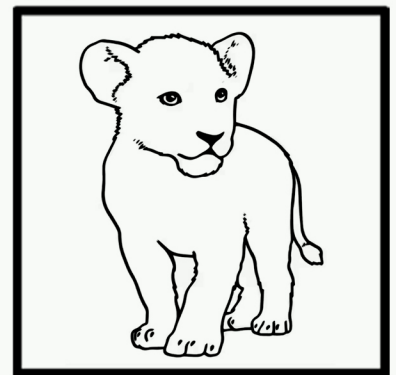

3.



cube

cub

6.

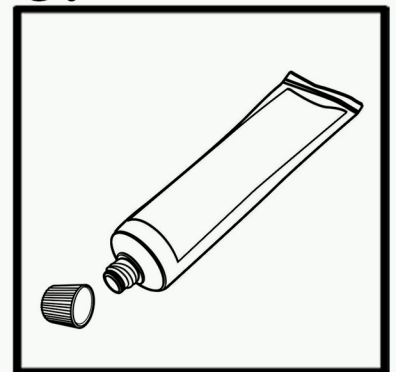

# The Reading Wizards

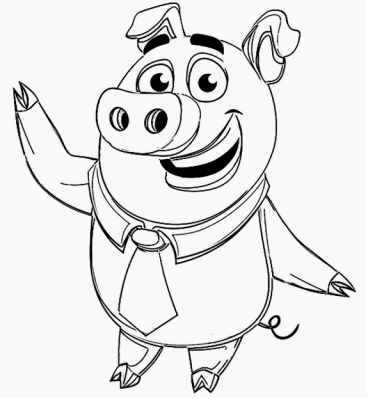

## Lesson 34B - Short and long U words with silent E

Directions: Write the word on the line that matches the picture.  
You can use the words in the box to help you with spelling.

cub tube cut cube tub cute

1.

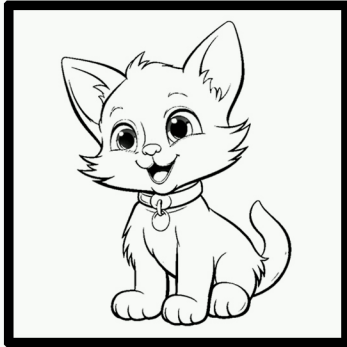

\_\_\_\_\_

-----

\_\_\_\_\_

4.

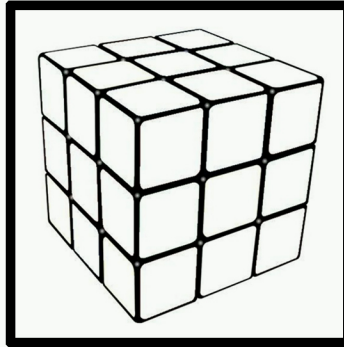

\_\_\_\_\_

-----

\_\_\_\_\_

2.



\_\_\_\_\_

-----

\_\_\_\_\_

5.

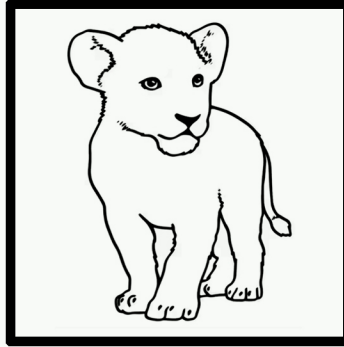

\_\_\_\_\_

-----

\_\_\_\_\_

3.



\_\_\_\_\_

-----

\_\_\_\_\_

6.

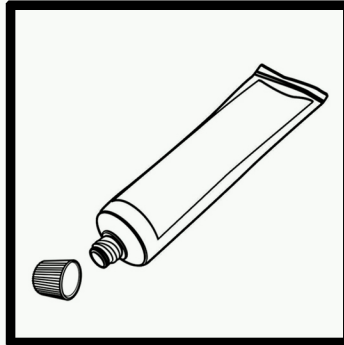

\_\_\_\_\_

-----

\_\_\_\_\_

# The Reading Wizards



## Lesson 34B - Short and long U words with silent E

Directions: Unscramble each word that matches the picture.

1.

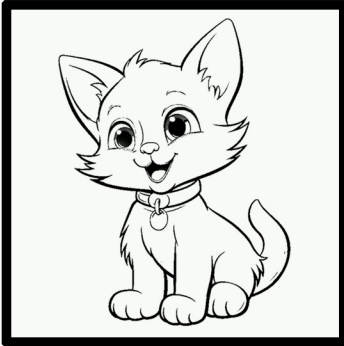

e c t u

— — — —

4.

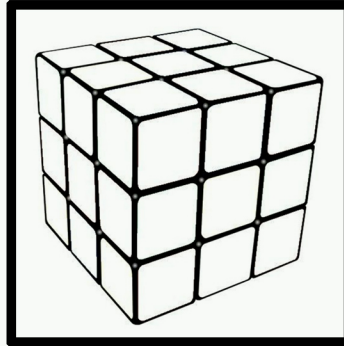

b u e c

— — — —

2.

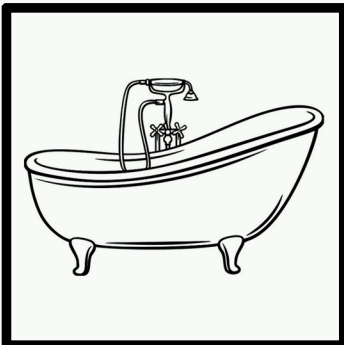

u t b

— — —

5.

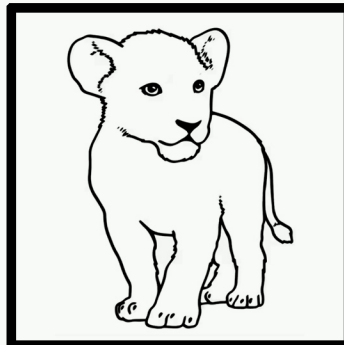

u b c

— — —

3.



t u c

— — —

6.

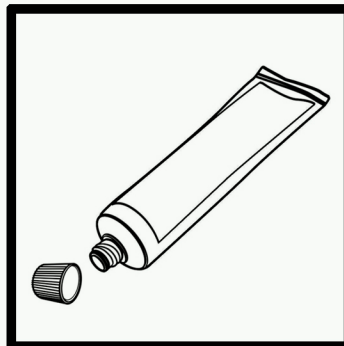

u b t e

— — — —

# The Reading Wizards



## Lesson 34B - Short and Long U words with silent E

Directions: Circle the words in the puzzle that match the list of words below.

cub tube cut cube tub cute

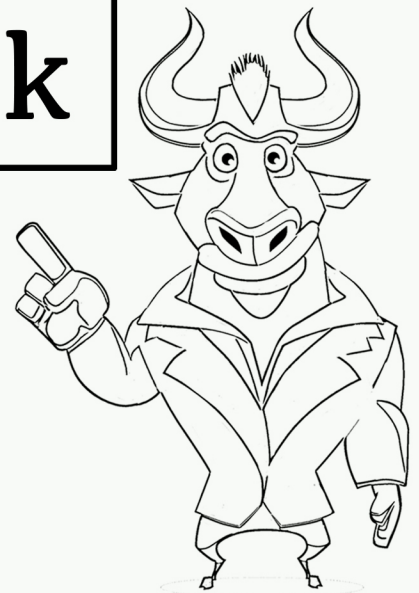
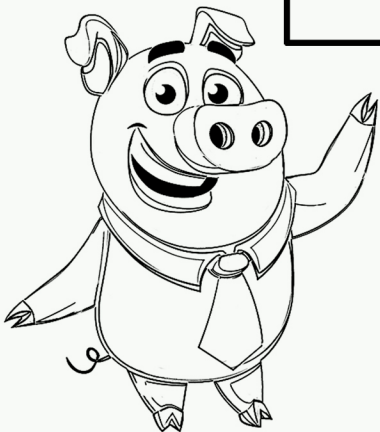
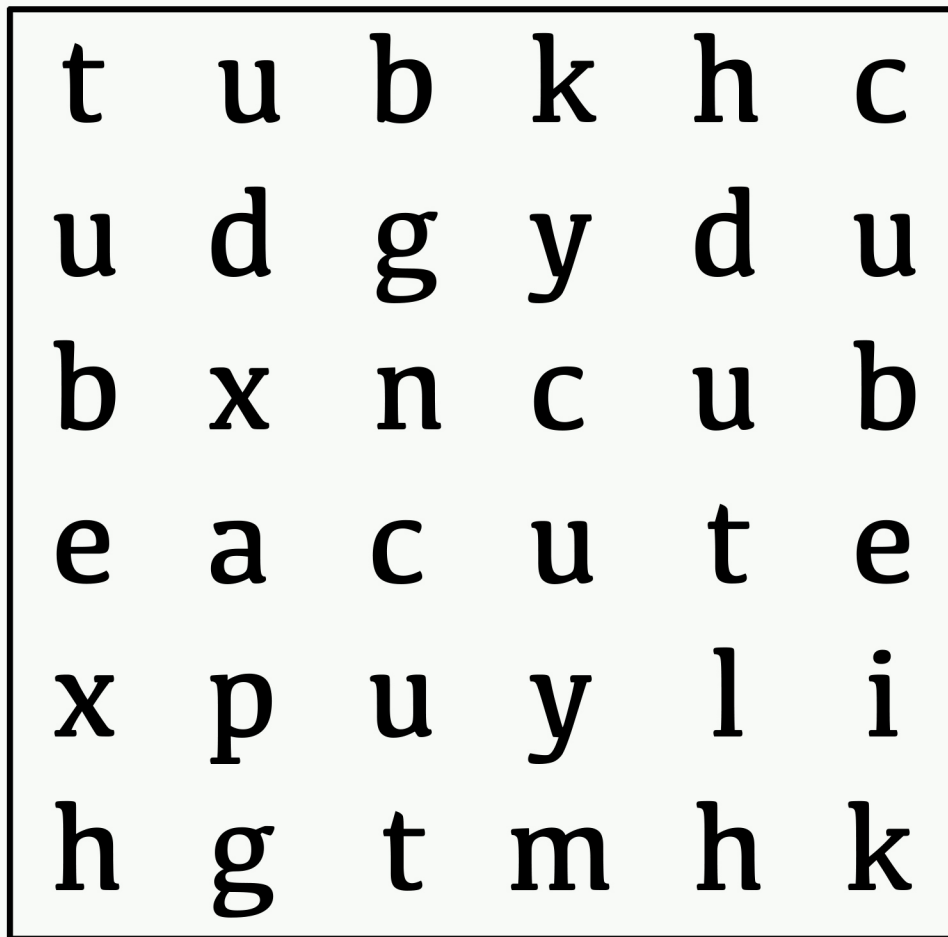

# The Reading Wizards

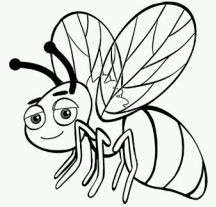

## Lesson 34B - Sentences.

Directions: Unscramble the words so that the sentences make sense.

1. cute. is cub The

---

---

---

2. in tube the is tub The

---

---

---

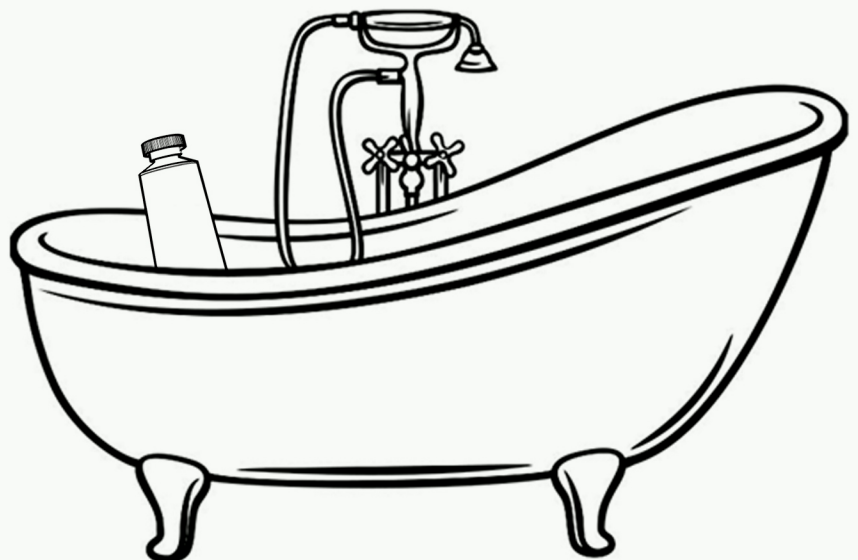
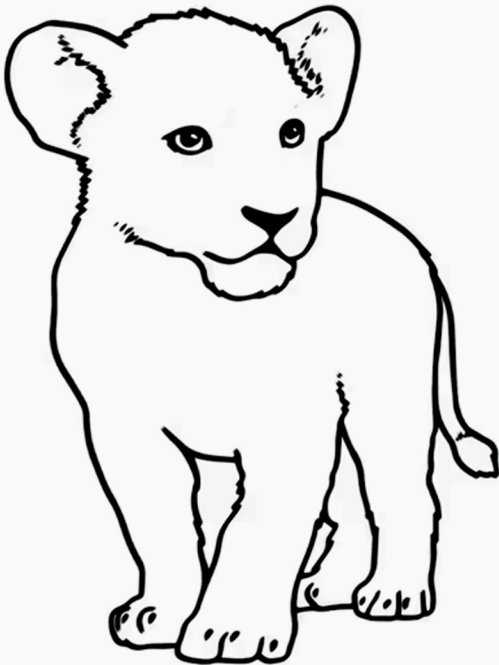

# The Reading Wizards

Lesson 34B - Answer key to Wordsearch and sentences.

Wordsearch answer key:

cub tube cut cube tub cute

t	u	b	k	h	c
u	d	g	y	d	u
b	x	n	c	u	b
e	a	c	u	t	e
x	p	u	y	l	i
h	g	t	m	h	k

Sentences answer key:

1. The cub is cute.
2. The tube is in the tub.